

KING || WiFiMax™

Wi-Fi Extender KWM 1000

(included with KS1000)



The KING WiFiMax creates your own private and secure Wi-Fi network, just like you have in your home. When in range of an available network, simply configure your WiFiMax to connect to that network, and it will extend the internet access from that network to your own private Wi-Fi network.

KING || SWIFT™

Omnidirectional Wi-Fi Antenna KS 1000

(not included with KWM1000)



The KING Swift is an omnidirectional Wi-Fi antenna that increases the range and performance of your KING WiFiMax router and range extender. This 2.4GHz Wi-Fi antenna mounts to your roof, connects to your KING WiFiMax via a single cable, and allows your KING WiFiMax to connect to networks from even farther away and still utilize its 5GHz network for fastest speeds.

CONTENTS

CONTENTS	2
CONNECTIONS	3
FIRST-TIME USE	4-7
STANDARD OPERATION	8-11
INSTALLATION	12-13
TROUBLESHOOTING	14
SPECIFICATIONS	15
LIMITED WARRANTY	16-17
WIRELESS REGULATORY INFORMATION	18-19

CONTENTS

KING WiFiMax KWM1000

For increased performance, you can add a KING Swift (contact KING Customer Service at 952-345-8147).

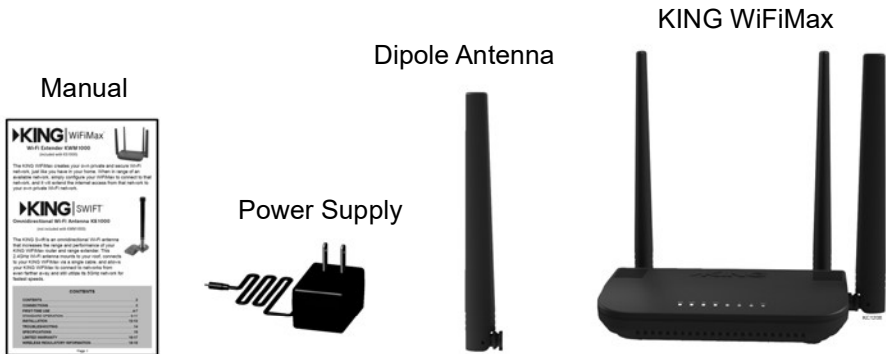

NOTE: No tools are required to set up and use the KING WiFiMax (unless wall mounting the unit).

There are key hole slots on the back to mount the unit to a wall. The user must determine where and how to best mount the unit to a wall (inside use only).

KING Swift KS1000

Includes the KING WiFiMax and power supply shown above.

KING Swift antenna with preattached cable

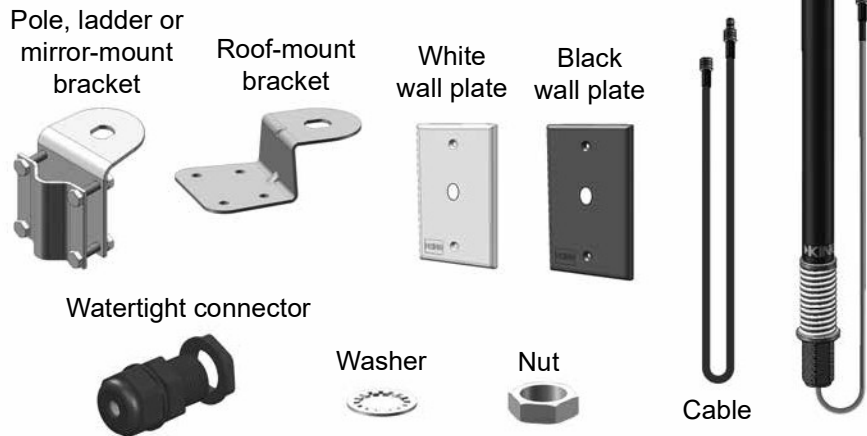

NOTE: The KING Swift, bracket and hardware may come preassembled.

For complete installation instructions see page 10.

CONNECTIONS

Place your KING WiFiMax on a stable surface (or wall mount).

Make connections as shown. (Blue lights on KING WiFiMax will turn on when power is connected.)

A Attach included dipole antenna or cable from KING Swift to open port.

B Rotate antennas so they point up.

C Connect to power.

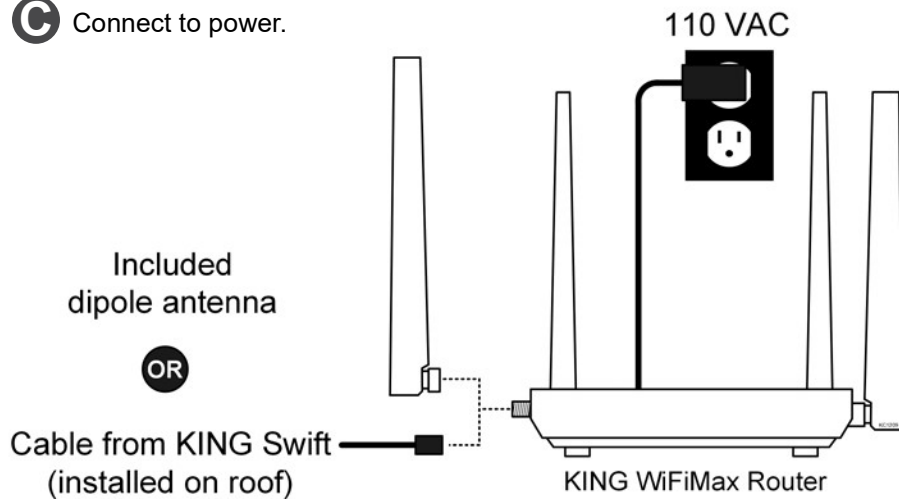

NOTE: You can use the keyhole slots on the back to wall mount the unit.

ANTENNAS MUST ALWAYS POINT UP.

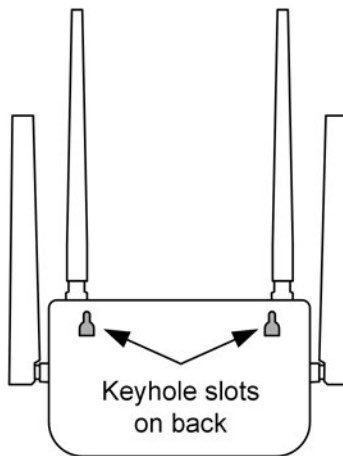

FIRST-TIME USE

NOTE: If you have already completed this first-time use section, go to page 8.

TIP When using a smart phone or tablet: to maintain the best connection to your KING WiFiMax, it is suggested that the smart phone or tablet's cellular network be turned off while completing the first-time use section.

1. Go to your smart phone, tablet or computer's Wi-Fi settings page and connect to the KING 5G network:

KING XXXXXX **5G**

TIP XXXXXX is a number/letter combination unique to your router and can be found on the bottom of your router in the SSID row.



Graphics will vary.

If you do not see **KING_XXXXXX_5G** (5GHz network), connect to **KING_XXXXXX** (2.4GHz network).

Always choose the 5G network if possible, as it is faster than the 2.4GHz network.

2. Open your device's web browser.

Go to: **http://mykingwifi.com**

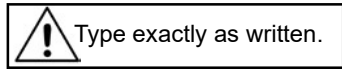

Tap "WiFi Settings" in the left-hand column.

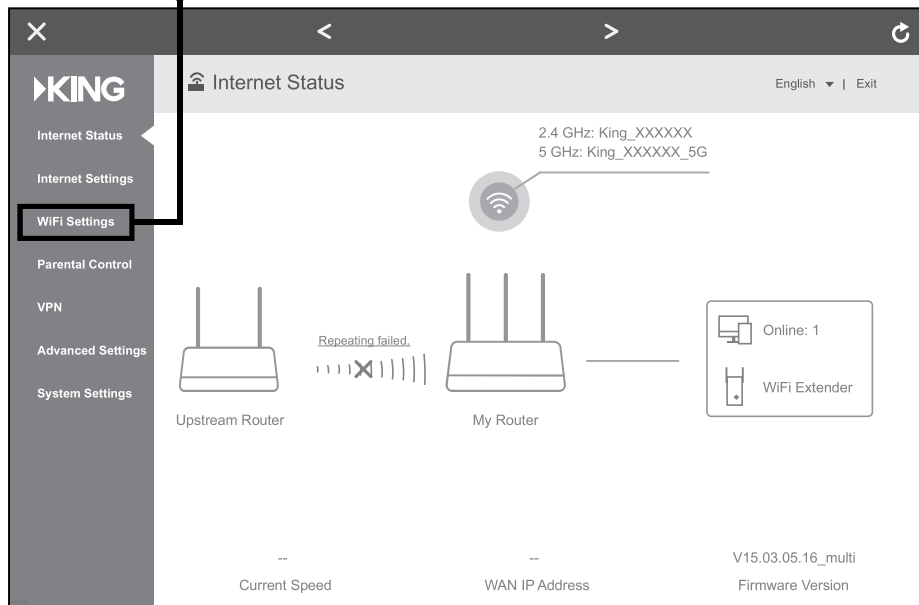

3. Tap "WiFi Name & Password."

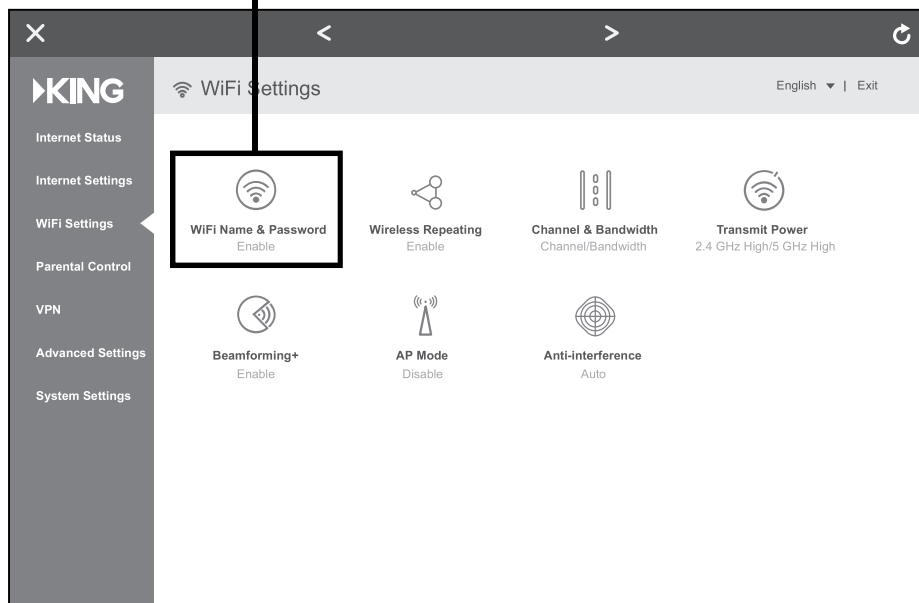

4. In the screen below, you **MUST** change your Wi-Fi name and password to personalize it and keep it secure. Do steps A and B for both the 2.4 GHz and 5GHz networks (you will only have to do this once).

A Enter a new Wi-Fi name.



When entering your new names, make sure to **completely erase** the existing names in the boxes.



Add “_5G” after your 5GHz network name to differentiate it from your 2.4GHz network name.

B Enter a password.



KING highly recommends password protecting your name. Choose WPA/WPA2-PSK under “Encryption Mode” to enable password protection.

Passwords can be the same for both networks if you wish, and must be at least 8 characters.



Enter names and passwords for both networks.

The screenshot shows the 'WiFi Name & Password' settings screen. It has two sections: '2.4 GHz Network' and '5 GHz Network'. Each section has a toggle switch, a 'WiFi Name' field with a 'Hide' checkbox, an 'Encryption Mode' dropdown menu, and a 'WiFi Password' field. Step A points to the 'WiFi Name' fields for both networks. Step B points to the 'WiFi Password' fields for both networks. A callout box points to the 'Encryption Mode' dropdown, which is set to 'WPA/WPA2-PSK', with the text 'Choose this encryption mode to enable password protection.'

2.4GHZ

Write your network name here:

Write your password here:

5GHZ

Write your network name here:

Write your password here:

5. When you have entered names and passwords for **both** networks, tap “Save.”

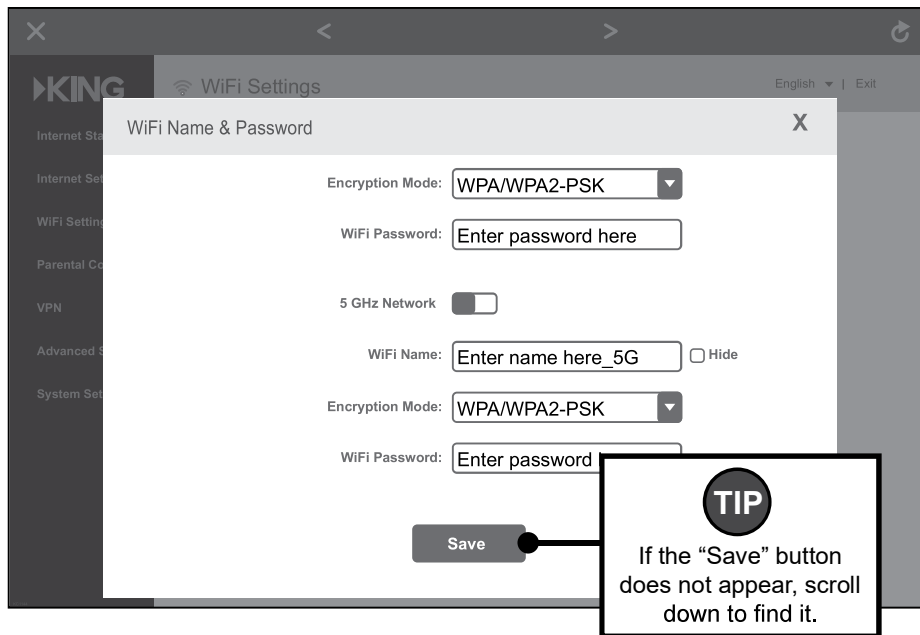

You have personalized your router setup.

Continue on next page.

TIP If you turned off your cellular network during first-time use, it is now safe to turn it back on.

STANDARD OPERATION

TIP When using a smart phone or tablet: to maintain the best connection to your KING WiFiMax, it is suggested that the smart phone or tablet's cellular network be turned off during standard operation.



1. Go to your phone, tablet or computer's settings page and connect to the Wi-Fi Network with your personalized network name (you created this on page 6).

The example shown is "MyWiFiName_5G".

If your device cannot connect to your 5G network, connect to your other network.

TIP For best performance, choose the 5GHz network whenever possible.

2. Open your device's web browser.

Go to: <http://mykingwifi.com> Type exactly as written.

Tap "WiFi Settings" in the left-hand column.

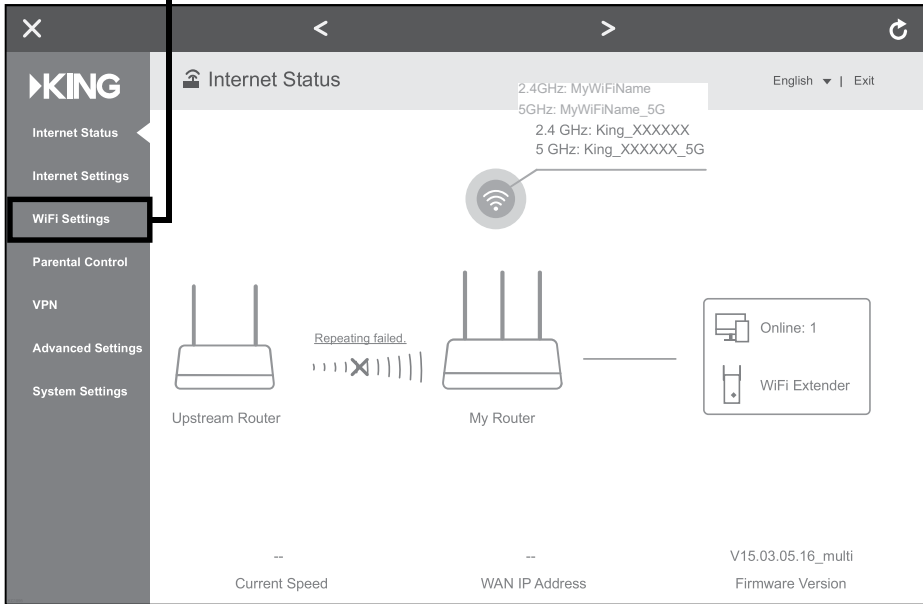

3. Tap "Wireless Repeating."

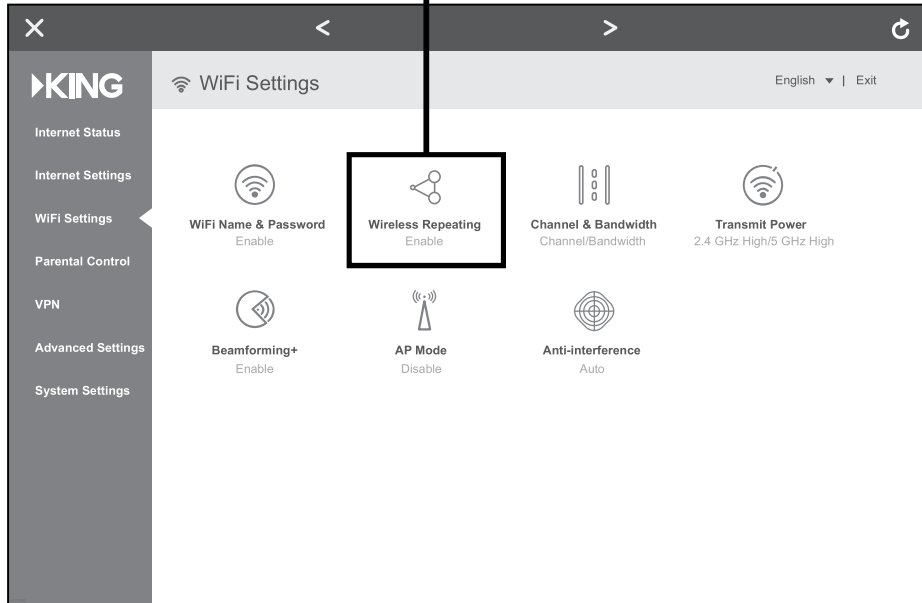

4. Tap the blue arrows to scan for networks.

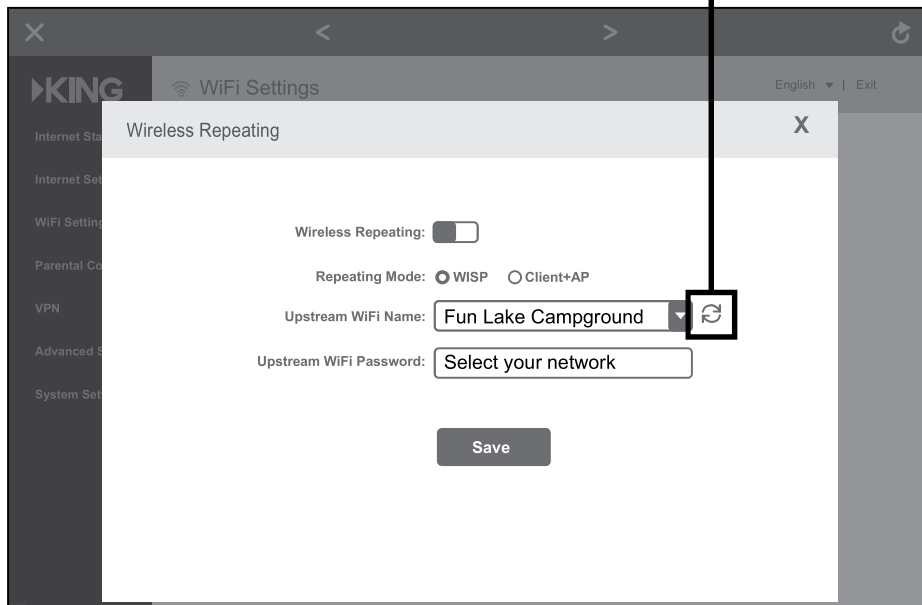

The router is scanning for networks.

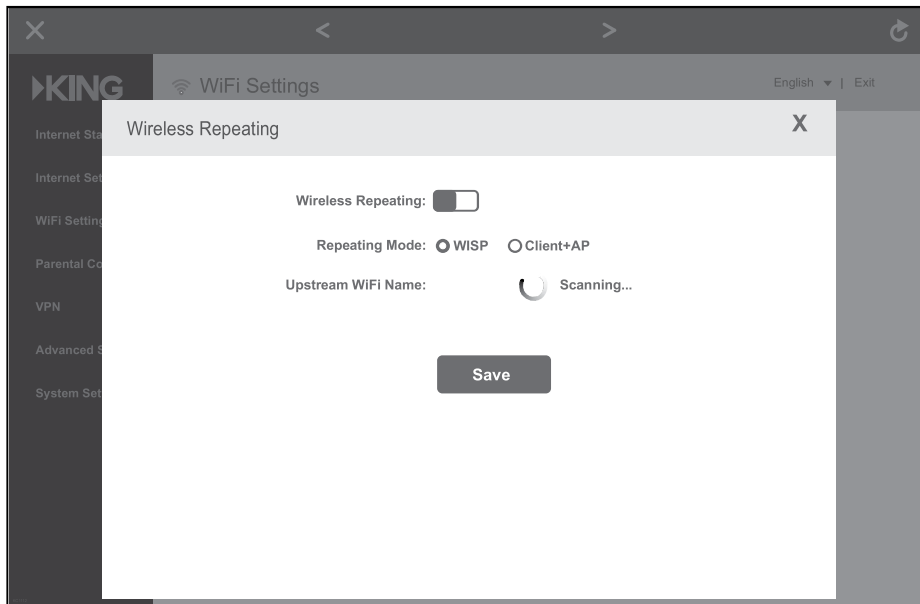

5. After the scanning process is complete, this screen will appear.

Tap on "Upstream WiFi Name" drop down menu to display a list of available networks.

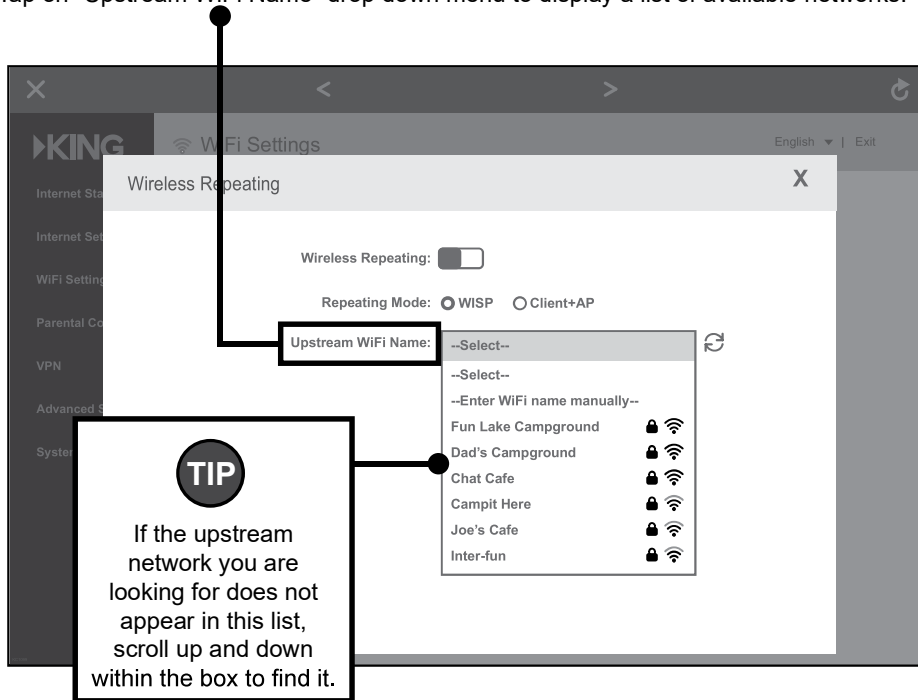

6. Select the network you would like to extend (not your customized router name) and input the password if necessary (not pictured).

Tap "Save."

7. This popup should appear. Tap "OK."

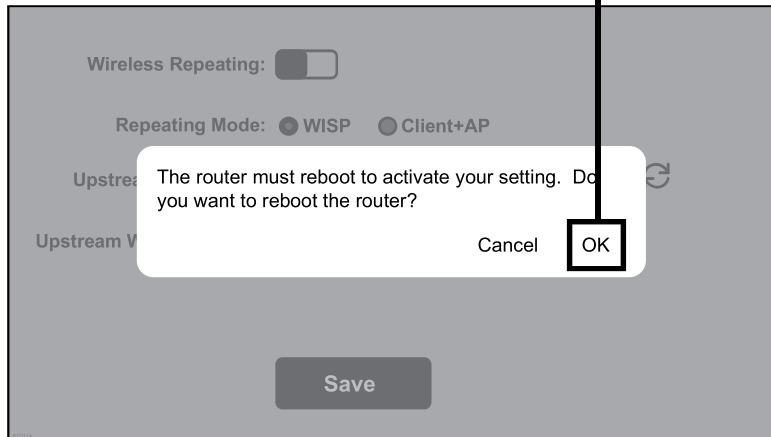

8. Your KING WiFiMax will reboot.

If your router gets stuck at 100% and won't finish rebooting,

or if your Wi-Fi device does not have internet access, you may need to go back to your smart phone or tablet's settings page and ensure that it reconnected to the Wi-Fi network with your personalized network name, as you may lose connection during the router's rebooting process.

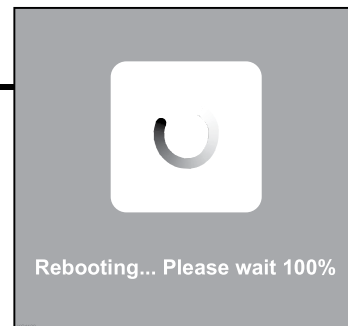

Your KING WiFiMax is now extending your network!



If you turned off your cellular network during standard operation, it is now safe to turn it back on.

INSTALLATION

- For best performance, the antenna should be located as far away as possible from other rooftop objects (TV antennas, AC units, etc.) and with the best all around line of sight.
 - When determining locations, make sure the long cable will reach the KING WiFiMax when attached to the KING Swift cable. (KING Swift cable may go directly to prewire enclosure - see opposite page).
 - Do not locate the KING WiFiMax or KING Swift in a slide-out.
 - Cable connection between KING Swift and long cable must always be inside vehicle (or prewire enclosure if using).
1. Drill 5/16" hole in roof where cable will enter roof. Feed long cable into position with enough cable sticking out of roof to attach KING Swift cable. **This end is marked "ROOF" and is red.**
 2. Connect KING Swift cable and long cable.
 3. Apply roof-compatible sealant around perimeter of bracket. Feed cable into hole, lower bracket into position and fasten to roof. **Seal fastener heads and cable hole in roof.**
 4. Inside vehicle, install wall plate if desired, and connect cable to KING WiFiMax.

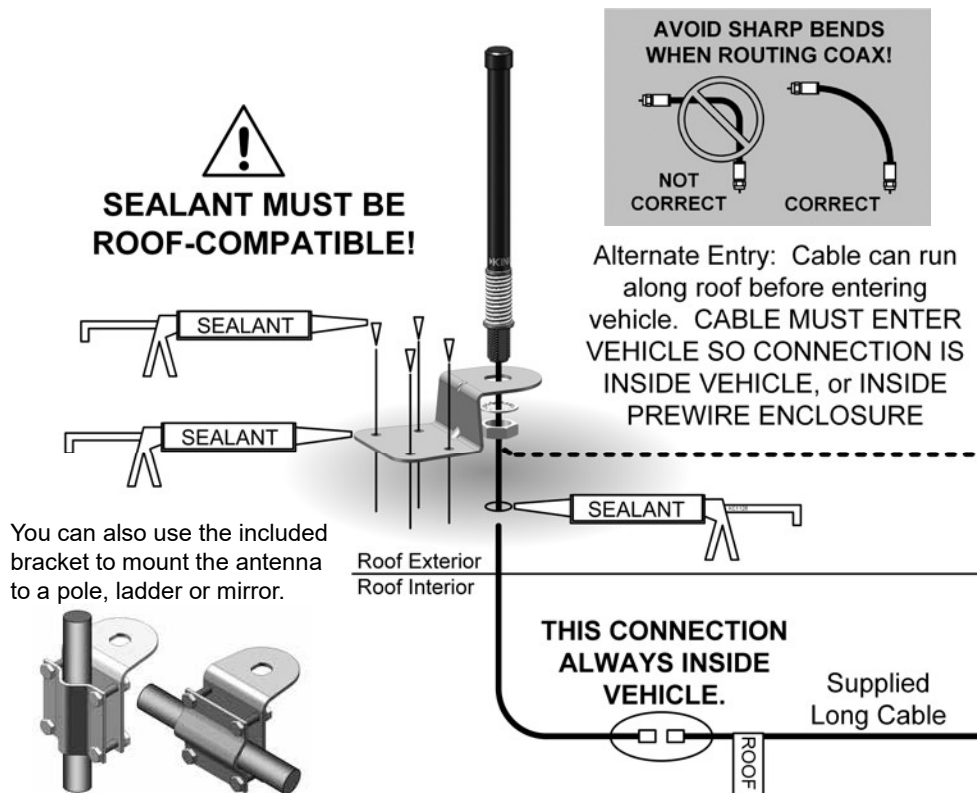

Prewire connections with OEM installed prewire enclosure

1. Remove (4) screws and take off the prewire cap.
2. Knock out the hole for the watertight connector.
3. Take the nut off the watertight connector.
4. Feed the cable through the connector, prewire cap, and nut.
5. Install the connector in the prewire cap with the nut.
6. Feed desired amount of cable through connector and tighten the connector's sealing nut.
7. Connect the two cables.
8. Replace the prewire cap and fasten with (4) screws.

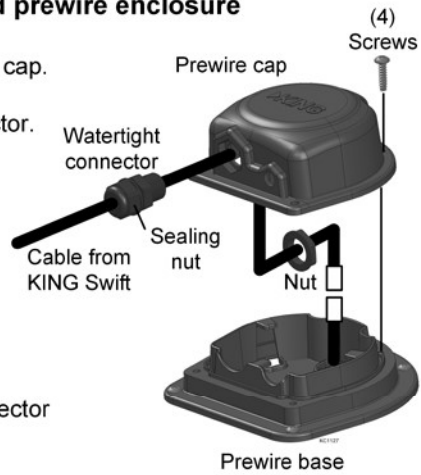

**DO NOT OVER-TIGHTEN
SCREWS INTO PLASTIC.**

**Cable connection must be
made inside enclosure,
NOT ON ROOF!**

IMPORTANT!
The installer is responsible for determining and supplying the most appropriate fasteners to secure the bracket to the roof.

All holes, fastener heads, and the entire perimeter of the bracket must be completely sealed and weatherproofed with roof-compatible sealant.

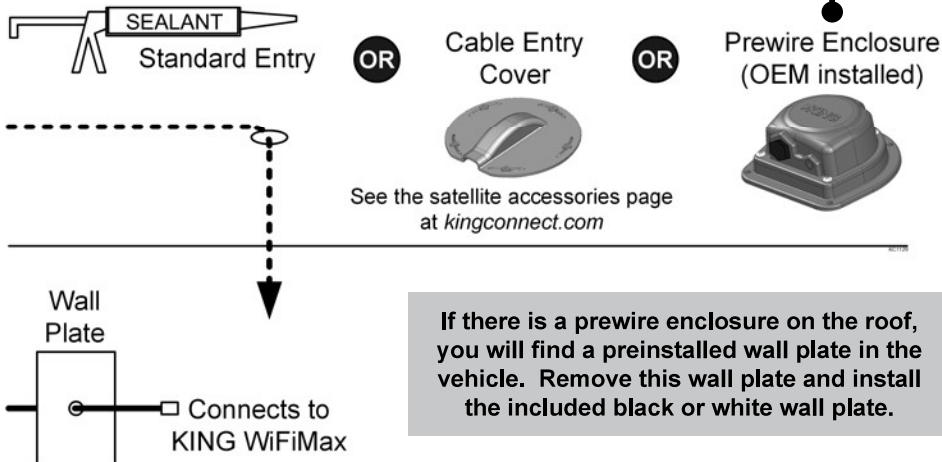

TROUBLESHOOTING

The KING WiFiMax doesn't power on (no blue lights on front).

Make sure power supply plug is securely inserted into back of KING WiFiMax. Make sure the power supply is plugged into a known good power outlet.

I can't find the network KING_XXXXXX_5G or KING_XXXXXX.

Make sure your KING WiFiMax is plugged in. It may take up to a minute for these networks to appear. Some older devices may be unable to see the 5GHz network. This is completely okay; just use the KING_XXXXXX network.

I can't connect to mykingwifi.com

Make sure you are connected to your KING WiFiMax's network. Then make sure you type in the web address exactly as it appears in this manual: <http://mykingwifi.com>.

I can't enter a password in the designated box.

Choose WPA/WPA2-PSK under "Encryption Mode" (right above the password box) to enable password protection.

I don't see the Upstream WiFi name I want to extend in my list of networks.

If a network is very far away or very weak, the KING WiFiMax may not be able to see it, or may not offer it as an option. Try scanning again for networks by clicking on the blue circular arrows. If your network is still not offered as an option, try moving your KING WiFiMax to a location closer to your desired network.

When my router reboots, it gets stuck at 100% and won't finish rebooting.

Try reloading the page. If the page won't load, make sure your device is still connected to the KING WiFiMax. It may have disconnected during the reboot.

The KING WiFiMax doesn't seem to extend the range of my Wi-Fi, or has trouble picking up signal from my source.

Make sure all 4 antennas (3 if KING Swift is connected) are pointing up. If wall mounting, antennas must be rotated to point up as well.

Certain types of obstructions (other vehicles, buildings, or large amounts of metal) can reduce signal levels. Try relocating the KING WiFiMax.

NOTE: KING WiFiMax can be reset by pressing and holding the reset button until the front lights go out (15-20 seconds).

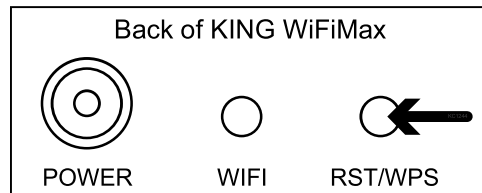

Let us help! KING Customer Service 952-345-8147

SPECIFICATIONS

KING WiFiMax

Power:	Included 12v power supply, requiring 110V AC plug-in
Wireless standards:	IEEE802.11a/b/g/n/ac
Supported Frequencies:	2.4GHz and 5GHz (dual-band)
Security:	WPA/WPA2-PSK
Storage Environment:	Temperature -40°F to 158°F

KING Swift

Radio Frequency Band:	2.4GHz
Wireless Standards:	IEEE802.11a/b/g/n
Antenna:	3dBi roof-mounted omnidirectional antenna
Height:	9.5"
Diameter:	0.75"
Weight:	0.25LBS

LIMITED WARRANTY

Each new KING WiFiMax and King Swift is thoroughly inspected and tested before leaving the factory, and is covered by the following limited warranty from the date of original purchase:

- One-year parts warranty: The customer is not responsible for the cost of replacement parts if the original part is determined to be defective under the terms of the warranty. The customer is responsible for the cost of replacement parts after one year.

Only KING and certified dealers may perform warranty evaluations and repairs. Depending upon the problem, KING may authorize a dealer to perform the necessary repairs. Any warranty labor outside of that performed at the factory is not covered unless 1) the product has been installed by an authorized dealer/installer or OEM manufacturer and 2) the dealer/installer receives prior authorization to perform the repair.

A certified dealer must not perform any repair without first contacting KING for a Service Order Number. KING will advise the dealer on how to proceed with any repairs.

Should any trouble develop during the warranty period, contact KING at (952) 345-8147. You must contact KING before the warranty period expires. The customer must supply proof of purchase (such as a dated sales receipt) when requesting warranty service. If the customer cannot supply proof of purchase, warranty period shall start 30 days after date of manufacture.

If it is determined that the unit needs to be returned to KING, customer must return COMPLETE product, freight prepaid, to:

KING, 11200 Hampshire Avenue South, Bloomington, MN 55438-2453.

If inspection shows the trouble is caused by defective workmanship or material, KING will repair (or at its option, replace) without charge.

When returning product, KING will supply an RMA number (Return Merchandise Authorization). This number must be clearly written on the box. Failure to clearly write RMA number on box will result in delays in processing claim. Along with product, the customer should include in the box: his/her name, address, daytime phone number, proof of purchase and description of the problem.

This warranty does not cover installation and external wiring, or remanufactured units. This warranty does not cover damage caused by the use of an accessory other than a KING accessory designed for the product. This warranty is not transferable from the original owner.

KING cannot be held responsible for changes in the expanding and changing digital and analog communications market that cause the product to no longer operate correctly.

This warranty also does not apply where:

- The product has been abused, misused, improperly installed or improperly maintained.
- The product has been used with an accessory other than a KING accessory designed for the product.
- Repairs have been made or attempted by others that are not certified by KING to do such repairs.
- Repairs are required because of normal wear and tear.
- Alterations have been made to the product.
- The product or any associated component has been opened without authorization or disassembled to any degree.
- Damage has been caused by power washing.
- Circumstances beyond the control of KING cause the product to no longer operate correctly.
- Customer is not the original owner.

In no event shall KING be liable for any indirect, incidental, or consequential damages from the sale or use of the product. This disclaimer applies both during and after the term of this warranty.

KING disclaims liability for any implied warranties, including implied warranties of “merchantability” and “fitness for a specific purpose,” after the term of this warranty.

This warranty gives you specific legal rights, and you may also have other rights, which vary from state to state. Some states do not allow the exclusion or limitation of incidental or consequential damages, so the above limitation or exclusion may not apply to you. Some states do not allow limitations on how long an implied warranty lasts, so the above limitation may not apply to you.

WIRELESS REGULATORY INFORMATION

FCC Statement

This device complies with part 15 of the FCC Rules. Operation is subject to the following two conditions: (1) This device may not cause harmful interference, and (2) this device must accept any interference received, including interference that may cause undesired operation.

Note: This equipment has been tested and found to comply with the limits for a Class B digital device, pursuant to part 15 of the FCC Rules. These limits are designed to provide reasonable protection against harmful interference in a residential installation. This equipment generates, uses and can radiate radio frequency energy and, if not installed and used in accordance with the instructions, may cause harmful interference to radio communications. However, there is no guarantee that interference will not occur in a particular installation. If this equipment does cause harmful interference to radio or television reception, which can be determined by turning the equipment off and on, the user is encouraged to try to correct the interference by one or more of the following measures:

- Reorient or relocate the receiving antenna.
- Increase the separation between the equipment and receiver.
- Connect the equipment into an outlet on a circuit different from that to which the receiver is connected.
- Consult the dealer or an experienced radio/TV technician for help.

FCC Caution

Any changes or modifications not expressly approved by the party responsible for compliance could void the user's authority to operate this equipment.

This transmitter must not be co-located or operating in conjunction with any other antenna or transmitter.

IEEE 802.11b or 802.11g operation of this product in the USA is firmware-limited to channels 1 through 11.

The device for the band 5150-5250 MHz is only for indoor usage to reduce the potential for harmful interference to co-channel mobile satellite systems.

Radiation Exposure Statement

This device complies with FCC radiation exposure limits set forth for an uncontrolled environment and it also complies with Part 15 of the FCC RF Rules. This equipment should be installed and operated with minimum distance 20 cm between the radiator and your body.

Innovation, Science and Economic Development Canada Statement

CAN ICES-3 (B)/NMB-3(B)

This device contains licence-exempt transmitter(s)/receiver(s) that comply with Innovation, Science and Economic Development Canada's licence-exempt RSS(s). Operation is subject to the following two conditions: (1) This device may not cause interference, and (2) This device must accept any interference, including interference that may cause undesired operation of the device.

For product available in the USA/Canada market, only channel 1-11 can be operated. Selection of other channels is not possible.

The device could automatically discontinue transmission in case of absence of information to transmit, or operational failure. Note that this is not intended to prohibit transmission of control or signaling information or the use of repetitive codes where required by the technology.

Innovation, Science and Economic Development Canada Radiation Exposure Statement

This equipment complies with ISED radiation exposure limits set forth for an uncontrolled environment. This equipment should be installed and operated with minimum distance 20 cm between the radiator and your body.

This device and its antenna(s) must not be co-located or operating in conjunction with any other antenna or transmitter except in accordance with ISED multi-transmitter product procedures.

Restrictions in the 5 GHz Band

The device for the band 5150-5250 MHz is only for indoor usage to reduce the potential for harmful interference to co-channel mobile satellite systems.

The maximum antenna gain permitted for devices in the band 5725-5825 MHz shall comply with the e.i.r.p. limits specified for point-to-point and non point-to-point operation as appropriate.

Users should also be advised that high-power radars are allocated as primary users (i.e. priority users) of the bands 5250-5350 MHz and 5650-5850 MHz and that these radars could cause interference and/or damage to LE-LAN devices.

This radio transmitter (6873A-KWM1000) has been approved by Innovation, Science and Economic Development Canada to operate with the antenna types listed below with the maximum permissible gain indicated. Antenna types not included in this list that have a gain greater than the maximum gain indicated for any type listed are strictly prohibited for use with this device.

Detachable antenna:

- 5 dBi at 2.4 GHz, 50Ω, Dipole

Additional requirements for the band 5600-5650 MHz

Until further notice, devices subject to this Section shall not be capable of transmitting in the band 5600-5650 MHz, so that Environment Canada weather radars operating in this band are protected.

Avis d'Innovation, Sciences et Développement économique Canada
CAN ICES-3 (B)/NMB-3(B)

L'émetteur/récepteur exempt de licence contenu dans le présent appareil est conforme aux CNR d'Innovation, Sciences et Développement économique Canada applicables aux appareils radio exempts de licence. L'exploitation est autorisée aux deux conditions suivantes : (1) L'appareil ne doit pas produire de brouillage; et (2) L'appareil doit accepter tout brouillage radioélectrique subi, même si le brouillage est susceptible d'en compromettre le fonctionnement.

Pour les produits disponibles sur le marché aux États-Unis et au Canada, seuls les canaux de 1 à 11 peuvent être utilisés. La sélection d'autres canaux n'est pas possible.

Le dispositif peut automatiquement cesser d'émettre en cas d'absence d'informations à transmettre, ou à cause d'une défaillance technique. Notez que l'objet n'est pas d'interdire la transmission des informations de contrôle ou de signalisation ou l'utilisation de codes répétitifs lorsque requis par la technologie.

Avis d'Innovation, Sciences et Développement économique Canada concernant l'exposition aux radiofréquences

Ce matériel est conforme aux limites établies par ISED en matière d'exposition aux radiofréquences dans un environnement non contrôlé. Ce matériel doit être installé et utilisé à une distance d'au moins 20 cm entre l'antenne et le corps de l'utilisateur.

Cet appareil et son (ses) antenne(s) ne doivent pas être situés à proximité ou fonctionner en association avec une autre antenne ou un autre émetteur autre qu'en respectant les procédures d'ISED relatives au fonctionnement des dispositifs multi-émetteurs.

Restrictions dans la bande 5 GHz

L'appareil pour la bande de 5150 à 5250 MHz est conçu pour usage à l'intérieur seulement afin de réduire le potentiel d'interférences pour les systèmes mobiles par satellite qui utilisent le même canal.

Le gain maximal d'antenne permis (pour les dispositifs utilisant la bande 5725-5825 MHz) doit se conformer à la limite de p.i.r.e. spécifiée pour l'exploitation point à point et non point à point, selon le cas.

De plus, les utilisateurs devraient aussi être avisés que les utilisateurs de radars de haute puissance sont désignés utilisateurs principaux (c.-à-d., qu'ils ont la priorité) pour les bandes 5250-5350 MHz et 5650-5850 MHz et que ces radars pourraient causer du brouillage et/ou des dommages aux dispositifs LAN-EL.

Le présent émetteur radio (6873A-KWM1000) a été approuvé par Innovation, Sciences et Développement économique Canada pour fonctionner avec les types d'antenne énumérés ci-dessous et ayant un gain admissible maximal. Les types d'antenne non inclus dans cette liste, et dont le gain est supérieur au gain maximal indiqué pour tout type figurant sur la liste, sont strictement interdits pour l'exploitation de l'émetteur.

Antenne détachable:

- 5 dBi à 2,4 GHz, 50Ω, Dipôle

Prescriptions supplémentaires pour la bande 5600-5650 MHz

Jusqu'à nouvel ordre, les appareils faisant l'objet de la présente section ne doivent pas transmettre dans la bande 5600-5650 MHz, afin que les radars météorologiques d'Environnement Canada fonctionnant dans cette bande soient protégés.

Simply better, by design.™



11200 Hampshire Avenue South, Bloomington, MN 55438
PH 952.922.6889 || FAX 952.922.8424 || kingconnect.com

©2020 KING 23180 Rev D

All trademarks are the sole property of their respective owners.